

Masonry Reinforcement



Heckmann Building Products

The POS-I-TIE® is a two piece system for attaching Brick Veneer to various existing backups. It incorporates a barrel-screw piece which allows easy installation using an ordinary drill with a special chuck adapter.

The barrel makes a positive contact with the backup wall transferring all compression and tension loads to the backup wall and not to the insulation/gypsum board.

The screws are a part of the system; therefore, no inferior screws can be substituted. The barrel is manufactured of ZAMAC 2 - a 92% zinc alloy. The screws are heat treated and Stalgard® coated for maximum corrosion resistance. Wire ties are available in Hotdip Galvanized After Fabrication or Stainless Steel.



A 16 gage Seismic Hook tab comes factory welded to the Pos-I-Tie® Tie for holding masonry reinforcement or pencil rod. Meets Seismic Zone requirements.

No. 75 Pos-I-Tie® Seismic Anchor

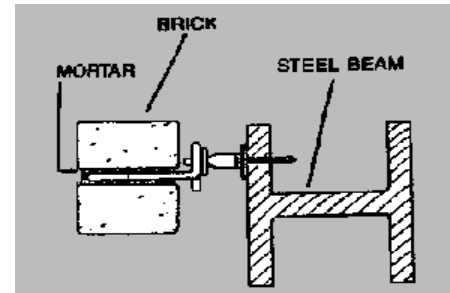
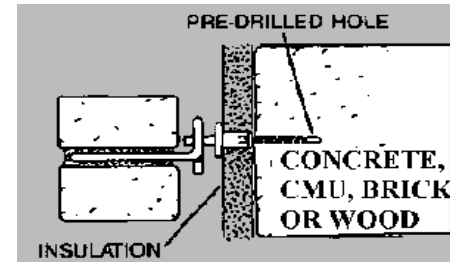
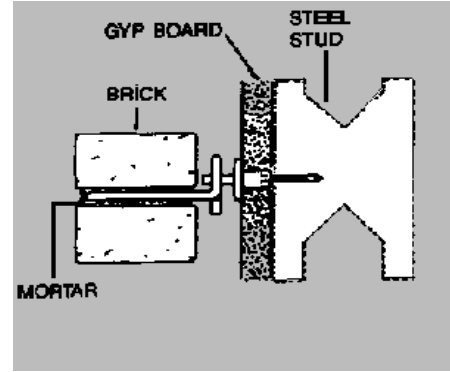

D/A 207 - MSSA Veneer Anchor Screw-On-Straps

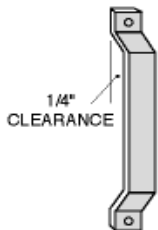

D/A 700 Series - Triangular Ties

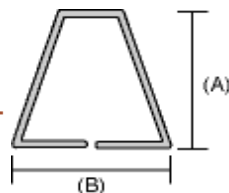

D/A 3100 - Truss

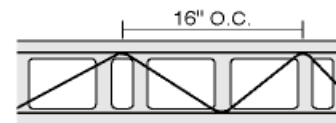

D/A 3200 - Ladur Type

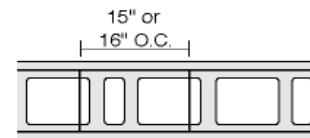

D/A 210 - Veneer Anchor Screw-On Plate

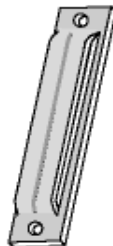

D/A 3700 - Dur-O-Eye

